



DATE PROJECT

COMMENTS

CERTIFICATIONS



## GEO REC SUSPENDED

DIRECT & INDIRECT / DIRECT

AN EXTENSION OF OUR SLĚK SERIES

FEATURES

The GEO Series provides specifiers with a creative lighting option to add depth and shape to a space. It combines the SLĚk's true 1" aperture with exceptional performance, accurate color, powerful illumination with an elegant lens.

### APPLICATIONS

- Conference Rooms
- Open Offices
- Hallways
- Combine with Square in the space

### CORNER JOINTS

Fully machined corner joint that provides excellent joint strength, eliminates light leak, and delivers fast and easy installation.

### PERFORMANCE

Up to 152 LPW for indirect/direct and up to 117 LPW for direct at 90 CRI.

### VERSATILITY

Direct and Indirect lumen intensity ranges from 200-1200 lm/ft in 3000K, 3500K and 4000K CCT provides specifiers with accurate and powerful levels of illumination and color within each space.

### OPTICS

A seamless and elegant roll in lens for the direct illumination provides uniform light distribution, controls glare, and eliminates light leaks. The upper optics consist of an extruded lens that provides an ultra wide batwing distribution to produce a more evenly illuminated ceiling and wider spacing of luminaires.

### REMOTE POWER UNIT

Easy to access wiring compartments. Designed to provide flexible, fast, and easy installation in multiple different mounting configurations.

SAMPLE PART NUMBER: GEO-ID-REC13-HU-HD-30-UNV-T1-WH-C90

ORDERING

| SERIES                 | PATTERN               | UPPER OUTPUT               | DIRECT OUTPUT              | CCT      | VOLTAGE               | MOUNTING           | COLOR                                |
|------------------------|-----------------------|----------------------------|----------------------------|----------|-----------------------|--------------------|--------------------------------------|
| GEO-D Direct           | REC13 1' x 3'         | BLANK = GEO-DIRECT         | HD 1000 LM/FT              | 30 3000K | UNV 120-277V          | T1 1" T-Grid       | WH White                             |
| GEO-ID Indirect/Direct | REC14 1' x 4'         | HU 1000 LM/FT              | MD 750 LM/FT               | 35 3500K | 347 <sup>1</sup> 347V | T9 9/16" T-Grid    | BLK Black                            |
|                        | REC16 1' x 6'         | MU 750 LM/FT               | LD 500 LM/FT               | 40 4000K |                       | SC Screw Slot Grid | S Silver                             |
|                        | REC23 2' x 3'         | LU 500 LM/FT               | VLD <sup>3</sup> 250 LM/FT |          |                       | HC Hard Ceiling    | GR Charcoal Gray                     |
|                        | REC24 2' x 4'         | VLU <sup>3</sup> 250 LM/FT | SLD <sup>4</sup> 125 LM/FT |          |                       | JB Junction Box    | CCC <sup>5</sup> Custom Corner Color |
|                        | REC26 2' x 6'         | SLU <sup>4</sup> 125 LM/FT | CD <sup>5</sup> Custom     |          |                       |                    |                                      |
|                        | C <sup>5</sup> Custom | CU <sup>5</sup> Custom     |                            |          |                       |                    |                                      |

OPTIONS

| CRI        | SUSPENSION <sup>2</sup> | CIRCUITING                                    | EMERGENCY <sup>6</sup>            | ORDERING NOTES   |
|------------|-------------------------|---|-----------------------------------|--|
| C90        |                         |   |                                   | 1 EM not available with 347V.  |
| C90 90 CRI | BLANK = 48" Cables      | BLANK = SINGLE CIRCUIT                        | EM <sup>1</sup> Emergency Battery | 2 For cable lengths longer than 144", consult factory.   |
|            | CB96 96" Cables         | SS-U/D Separate Switching                     | CEC LISTED                        | 3 VLU/VLD not available on 2 ft length.  |
|            | CB144 144" Cables       | UPLIGHT SWITCHED SEPARATELY FROM DIRECT LIGHT | EC Emergency Circuit              | 4 SLU/SLD not available on 2 ft and 3 ft lengths.  |
|            | BC Black Canopy & Cord  |   |                                   | 5 Contact factory for available configurations, additional lead times, and adder   |
|            |                         |   |                                   | 6 Contact factory for Emergency Battery (EM) and Circuit (EC) options with patterns. Factory drawings approval required. |

# GEO REC SUSPENDED

## DIRECT & INDIRECT / DIRECT



### PHOTOMETRICS & ENERGY CHARTS

#### GEO-D-REC14-MD-35-UNV-XX-C90

Distribution: Direct  
 Total Lumens: 3028  
 Ratio: 0% Up & 100% Down  
 Wattage: 26.2  
 Efficacy: 116 LM/W  
 Fixture Length: Four Feet  
 UGR: 25  
 4H X 8H Cross wise, Reflectance - Ceiling: 0.7, Wall: 0.5, Floor: 0.2

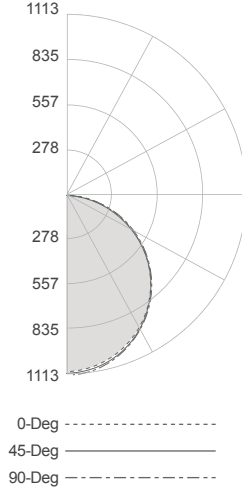

#### Zonal Lumen Summary

| Zone     | Lumens | % Fixt |
|----------|--------|--------|
| 0 - 30   | 839    | 27.7%  |
| 0 - 40   | 1359   | 44.9%  |
| 0 - 60   | 2367   | 78.2%  |
| 0 - 90   | 3027   | 100%   |
| 90 - 180 | 0      | 0%     |
| 0 - 180  | 3028   | 100%   |

#### Direct (Lambertian) Light at 90 CRI

|                  | HD:1000 | MD:750 | LD:500 | VLD:250 | SLD:125 |
|------------------|---------|--------|--------|---------|---------|
| <b>Watts/ft</b>  | 8.8     | 6.6    | 4.4    | 2.3     | 1.1     |
| <b>Lumens/ft</b> | 980     | 757    | 514    | 269     | 124     |
| <b>LPW</b>       | 110.9   | 115.6  | 115.8  | 117.6   | 122.7   |

#### GEO-ID-REC14-MU-MD-35-UNV-XX-C90

Distribution: Indirect/Direct  
 Total Lumens: 5877  
 Ratio: 50% Up & 50% Down  
 Wattage: 44.1  
 Efficacy: 133 LM/W  
 Fixture Length: Four Feet  
 UGR: 28.9  
 4H X 8H Cross wise, Reflectance - Ceiling: 0.7, Wall: 0.5, Floor: 0.2

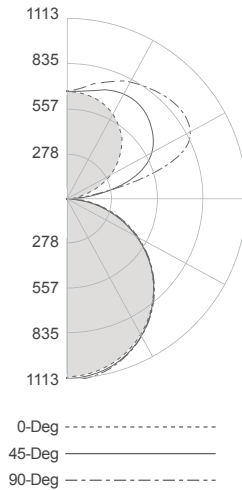

#### Zonal Lumen Summary

| Zone     | Lumens | % Fixt |
|----------|--------|--------|
| 0 - 30   | 839    | 14.3%  |
| 0 - 40   | 1359   | 23.1%  |
| 0 - 60   | 2367   | 40.3%  |
| 0 - 90   | 3027   | 49.7%  |
| 90 - 120 | 793    | 13.5%  |
| 90 - 130 | 1317   | 22.4%  |
| 90 - 150 | 2256   | 38.4%  |
| 90 - 180 | 2849   | 48.5%  |
| 0 - 180  | 5877   | 100%   |

#### Indirect (Batwing) / Direct (Lambertian) Light at 90 CRI

|                  | HU-HD | HU-MD | HU-LD | HU-VLD | HU-SLD |
|------------------|-------|-------|-------|--------|--------|
| <b>Watts/ft</b>  | 14.9  | 12.6  | 10.5  | 8.3    | 7.1    |
| <b>Lumens/ft</b> | 1948  | 1725  | 1482  | 1237   | 1092   |
| <b>LPW</b>       | 131   | 137.1 | 141.6 | 148.8  | 153.2  |

|                  | MU-HD | MU-MD | MU-LD | MU-VLD | MU-SLD |
|------------------|-------|-------|-------|--------|--------|
| <b>Watts/ft</b>  | 13.3  | 11    | 8.9   | 6.8    | 5.6    |
| <b>Lumens/ft</b> | 1692  | 1469  | 1226  | 981    | 836    |
| <b>LPW</b>       | 127   | 133.2 | 137.5 | 145    | 149.8  |

|                  | LU-HD | LU-MD | LU-LD | LU-VLD | LU-SLD |
|------------------|-------|-------|-------|--------|--------|
| <b>Watts/ft</b>  | 11.9  | 9.7   | 7.5   | 5.4    | 4.2    |
| <b>Lumens/ft</b> | 1470  | 1247  | 1004  | 759    | 614    |
| <b>LPW</b>       | 123.1 | 129.3 | 133.2 | 140.9  | 146.3  |

|                  | VLU-HD | VLU-MD | VLU-LD | VLU-VLD | VLU-SLD |
|------------------|--------|--------|--------|---------|---------|
| <b>Watts/ft</b>  | 10.5   | 8.2    | 6.1    | 3.9     | 2.8     |
| <b>Lumens/ft</b> | 1231   | 1008   | 765    | 520     | 375     |
| <b>LPW</b>       | 117.4  | 123    | 125.7  | 132.2   | 136.5   |

|                  | SLU-HD | SLU-MD | SLU-LD | SLU-VLD | SLU-SLD |
|------------------|--------|--------|--------|---------|---------|
| <b>Watts/ft</b>  | 9.7    | 7.4    | 5.3    | 3.1     | 1.9     |
| <b>Lumens/ft</b> | 1106   | 883    | 640    | 395     | 250     |
| <b>LPW</b>       | 114.4  | 119.7  | 121.5  | 126.8   | 129.7   |

# GEO REC SUSPENDED

## DIRECT & INDIRECT / DIRECT

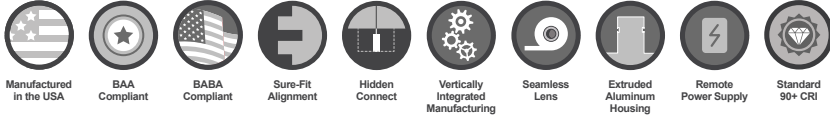

### DISTRIBUTION & CROSS SECTIONS

### CORNER JOINT

#### DISTRIBUTION: INDIRECT/DIRECT

#### DISTRIBUTION: DIRECT



#### CROSS-SECTION

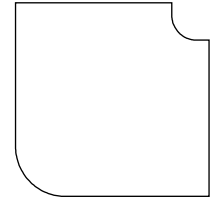
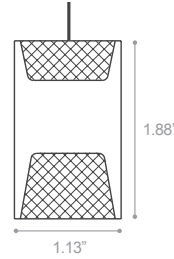

90°  
Two Legs

### STANDARD PRODUCT INFORMATION

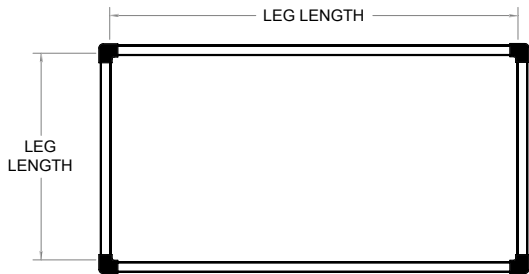

#### Product Dimensions

| ORDERING | LEG LENGTH |
|----------|------------|
| REC-13   | 1' & 3'    |
| REC-14   | 1' & 4'    |
| REC-16   | 1' & 6'    |
| REC-23   | 2' & 3'    |
| REC-24   | 2' & 4'    |
| REC-26   | 2' & 6'    |

### STANDARD SHAPE - CUSTOMIZED LENGTHS

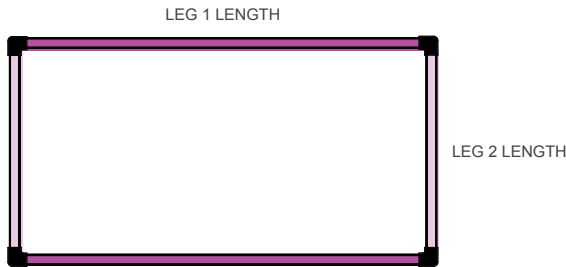

| SHAPE | LEG 1 LENGTH     | LEG 2 LENGTH |
|-------|------------------|--------------|
| REC-C |                  |              |
| REC-C | Rectangle Custom |              |

NOTE: 1' Increments (Ex: 1' = 001)

### CUSTOMIZED LENGTH NOTES

### ORDER GUIDE

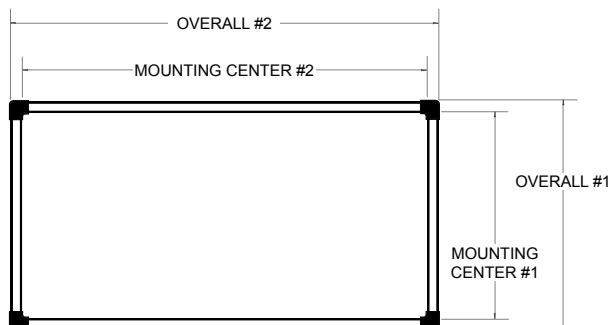

| SIZE/DISTRIBUTION  | REC-13<br>DIRECT &<br>INDIRECT / DIRECT | REC-14<br>DIRECT &<br>INDIRECT / DIRECT | REC-16<br>DIRECT &<br>INDIRECT / DIRECT | REC-23<br>DIRECT &<br>INDIRECT / DIRECT |
|--------------------|---|---|---|---|
| MOUNTING CENTER #1 | 14.3                                    | 14.3                                    | 14.3                                    | 26.5                                    |
| #2                 | 37.2                                    | 49.2                                    | 19.2                                    | 37.2                                    |
| OVERALL #1         | 16.4                                    | 16.4                                    | 16.4                                    | 28.5                                    |
| #2                 | 39.3                                    | 51.3                                    | 75.3                                    | 39.3                                    |

| SIZE/DISTRIBUTION  | REC-24<br>DIRECT &<br>INDIRECT / DIRECT | REC-26<br>DIRECT &<br>INDIRECT / DIRECT |
|--------------------|---|---|
| MOUNTING CENTER #1 | 26.5                                    | 26.5                                    |
| #2                 | 49.2                                    | 19.2                                    |
| OVERALL #1         | 28.2                                    | 28.5                                    |
| #2                 | 51.3                                    | 75.3                                    |

# GEO REC SUSPENDED

## DIRECT & INDIRECT / DIRECT



### REMOTE DRIVER MOUNTING OPTIONS: DETERMINED BY MOUNTING TYPE

#### ABOVE GRID: T1 - T9 - SC

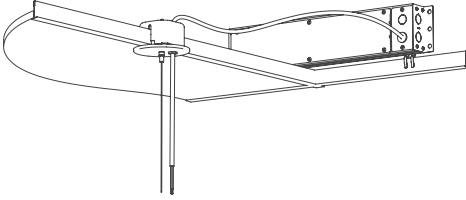

#### HARD CEILING: HC

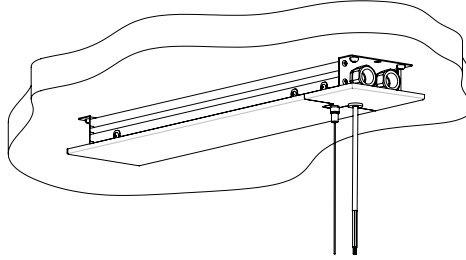

#### J-BOX: JB

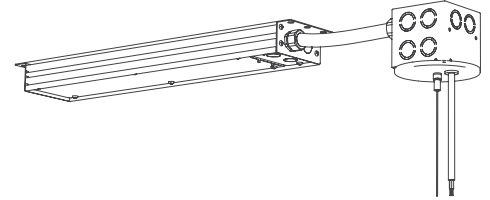

### REMOTE DRIVER DETAILS

#### SHORT REMOTE POWER UNIT

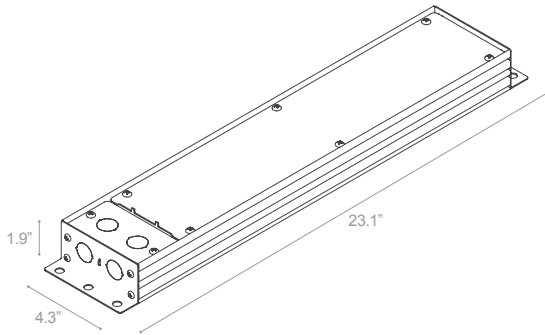

|                             | SHORT REMOTE POWER UNIT | LONG REMOTE POWER UNIT |
|-----------------------------|-------------------------|------------------------|
| <b>DISTRIBUTION</b>         |                         |                        |
| Indirect/Direct (SLK-ID)    | X                       | X                      |
| Direct (SLK-D)              | X                       | X                      |
| <b>MOUNTING</b>             |                         |                        |
| Hard Ceiling                | X                       | X                      |
| Grid (T1 - T9 - SC)         | X                       | X                      |
| J-Box                       | X                       | X                      |
| <b>ADD-ON OPTIONS</b>       |                         |                        |
| Separate Switching (SS-U/D) | X                       | X                      |
| Emergency Battery Pack (EM) |                         | X                      |
| Emergency Circuit (EC)      | X                       | X                      |
| <b>IC RATED</b>             |                         |                        |
| Approved                    |                         | X                      |

#### LONG REMOTE POWER UNIT

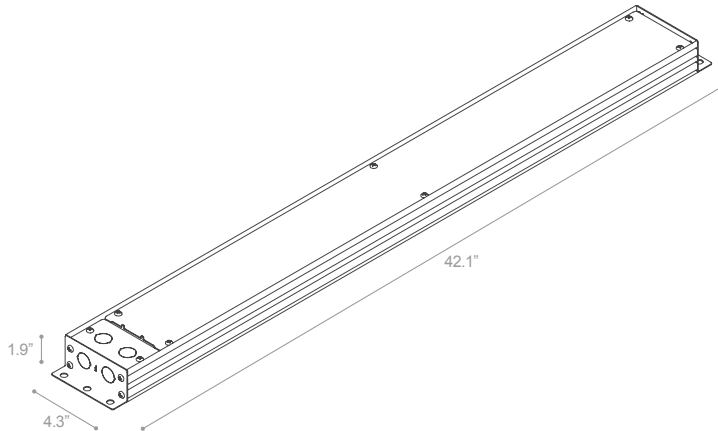

# GEO REC SUSPENDED

DIRECT & INDIRECT / DIRECT

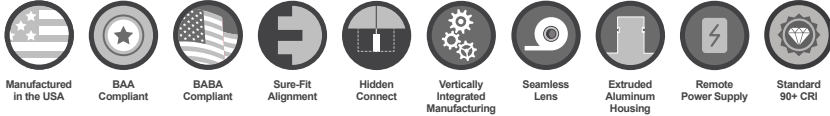

## SPECIFICATIONS

### MECHANICAL

#### Housing Construction:

Extruded aluminum 6063-T5 alloy outer housing and our high-quality die-cast end caps are engineered to conceal all fasteners, and to retain the sealing gaskets on the inside of the fixture while completing the clean and minimalistic look of this luminaire.

#### Mounting Method/Hardware:

Standard hanging hardware includes 1/16" diameter, galvanized steel aircraft cable with adjustable and lockable nickel-plated cable grippers at the luminaire. White or black 18/4 S.J.T. cord carries low voltage to luminaire. The standard hardware includes a 57" power cord and 60" aircraft cables to accommodate a 48" mounting distance from the ceiling. Ceiling canopy provided. All suspension hardware is tested and listed to UL1598 requirements for loading/fixture support.

#### Fixture Finish:

The GEO fixture finish is available in White, Black, Silver, or Charcoal Gray polyester powder coat finish to ensure durability. Exposed, direct trim surrounding acrylic lens to be painted specified finish. Luminaires are available in any RAL color as an option.

#### Corner Joints:

Fully machined aluminum corner joints with 2 mounting screws per fixture to provide strength. A sheet metal connector cover connects the multiple fixtures and hanging hardware together. This allows easy install and final wiring. Wiring is completed prior final corner joint is installed. Corner joint and sheet metal connector cover are joined with a 1/4"-20 screw.

### OPERATION

#### Remote Power Unit:

Remote Power Unit powers only one luminaire at a time. In row configurations, one power unit is required for each luminaire. Easy to access wiring compartments for fast and easy installation. Line voltage and low voltage wire compartments.

Remote Box Mounting Configurations:

- Above T-Grid with supplied clips
- Decorative surface mount on hard sheet rock construction
- Recessed in hard sheet rock construction (IC Rated)
- J-Box Mounted

#### Light Engine:

The GEO is available in 3000K, 3500K, and 4000K CCT all within a 3-Step MacAdam Ellipse and has a standard CRI of 90+.

#### Lower Optics:

Our frosted acrylic roll in lens is designed to maximize efficiency while minimizing glare and eliminating light leak at fixture joints. Fixtures come with lens installed.

#### Upper Optics:

The upper optics consist of an extruded acrylic lens that provides a ultra-wide batwing distribution to produce a more evenly illuminated ceiling and wider spacing of luminaires.

#### Electrical:

Electrical connections at fixture are preinstalled with low voltage wiring. Class 2 programmable (factory pre-set) premium power supply, 120-277VAC or 347V input. Power factor >0.9 THD<15%. Integral Surge Protection to 2KV.

#### Dimming:

The GEO comes standard with 0-10V dimming to 1%.

#### Emergency Battery Pack:

Emergency Battery Pack has been engineered to exceed UL minimum safety standards. Standard battery is CEC Listed. For most fixtures, the entire direct portion of the fixture will be illuminated by the EM Battery Pack.

#### Emergency Circuit:

Emergency Circuit fixtures are engineered so that the entire direct illumination is wired to the emergency circuit.

### GENERAL

#### Warranty:

Ten (10) year limited warranty from date of shipment, covers LED's, driver and luminaire. Optional accessories are covered by their individual Manufacturers' warranties.

#### Lumen Maintenance:

Rated for 85% initial lumen output (L85) at 90,000 hours of operation, operated at 25°C ambient temperatures; per TM-21 Guidelines published by the Illuminated Engineering Society (IES).

#### Certification:

All luminaires are UL/cUL Listed to UL 1598 Standards and approved for Indoor use in Dry/Damp Locations.

Remote Box Driver may be IC rated as an option. Contact Lumato for more information.

#### Manufactured in the USA:

All Lumato luminaires and components (with the exception of our LED boards and drivers) are proudly manufactured and assembled in the USA. All luminaires are UL/cUL Listed to UL 1598 Standards and approved for Indoor use in Dry/Damp Locations.

#### Shipping:

6-week lead-time for orders up to 1000 linear feet.

Lead-time for orders greater than 1000 linear feet will be determined at time of order.